

IEP

	702.910.020 Rev. D	Indica:
		0
	UNITATE CENTRALĂ	Fila
		1/9
data: 7.11.1987		Produs: ALPAGRAM 200

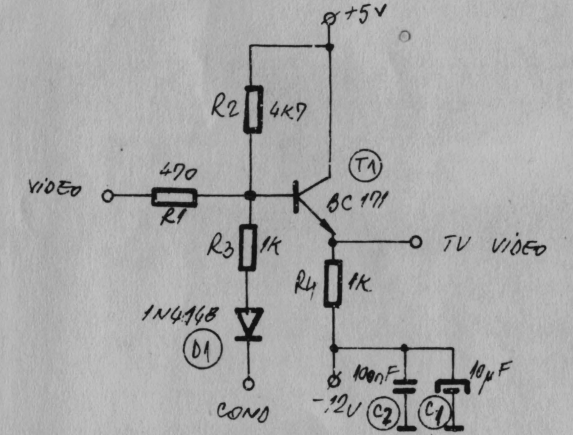
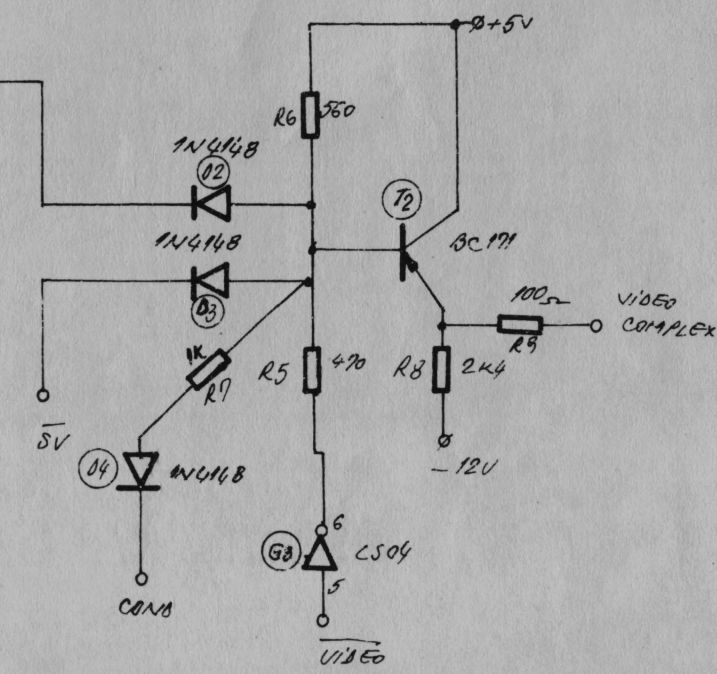
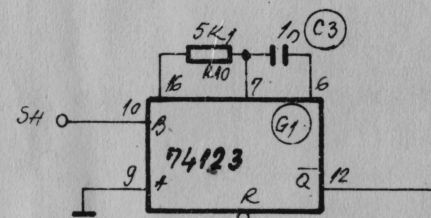
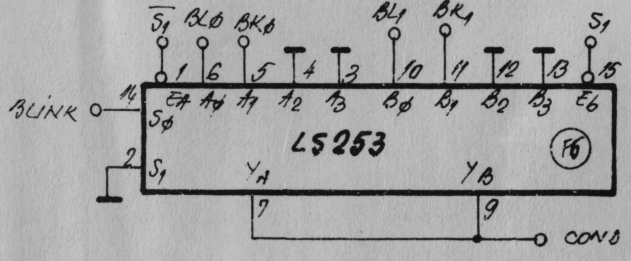
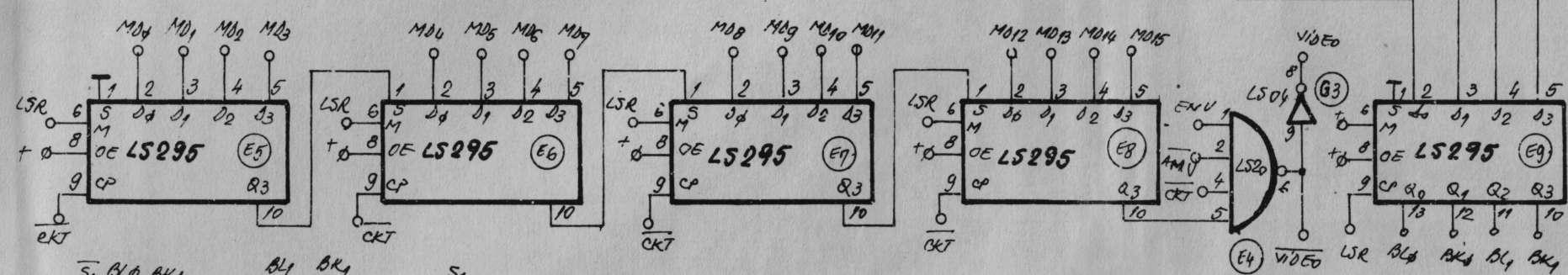
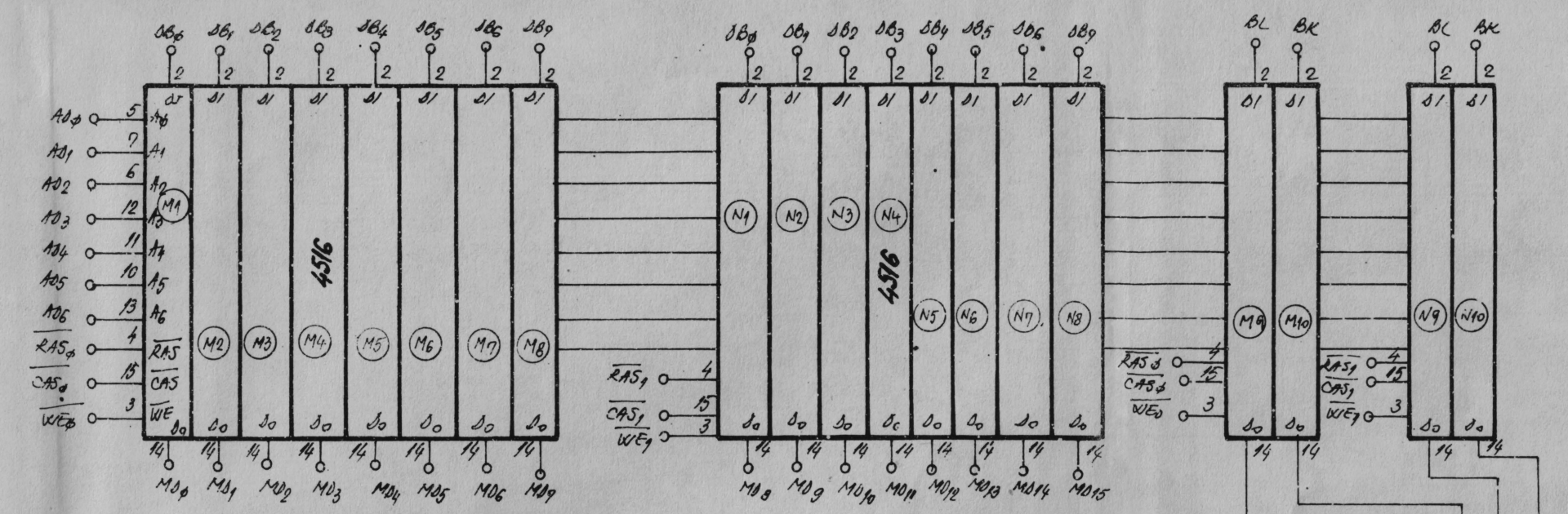

IEP

	702.910.020 Rev.D	indice:
		0
	MEMORIA DE ECRAN, REGISTRE DE SERIALIZARE SI IESIREA VIDEO	File:
		27
data: 20.11.1989	Produs: ALFAGRAF 200	

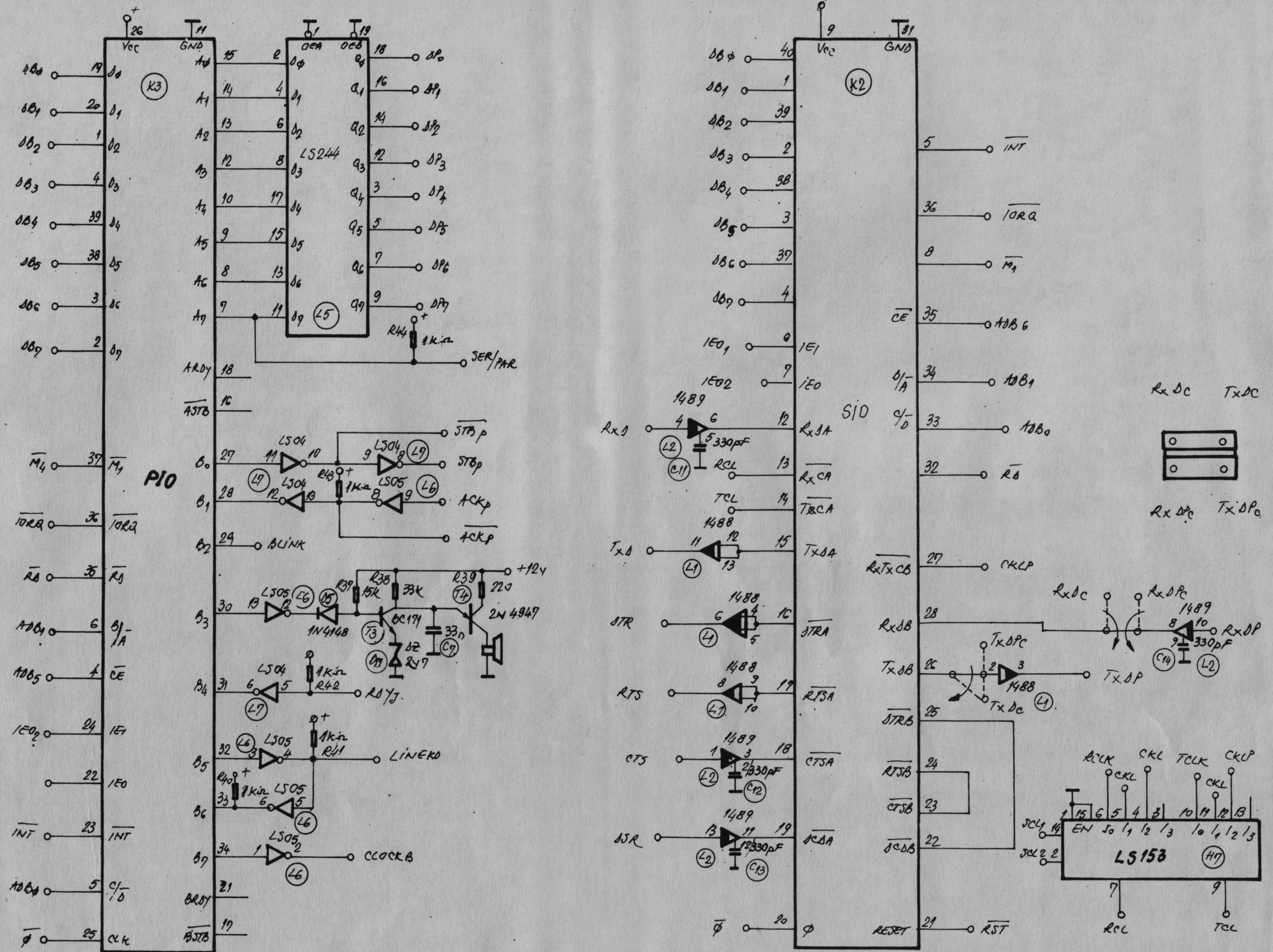

NOTĂ: — reprezintă configurația cu o placă
 - - - reprezintă configurația cu două plăci

I.E.P.

	702.910.020 Rev. D	Indice: 0
	INTERFETE TASTATURA IMPRINTA PARALELA/SERIA- LA SI COMUNICATIE	Fia: 3/1
data: 19.11.1989	Produs: ALFAGRAF 200	

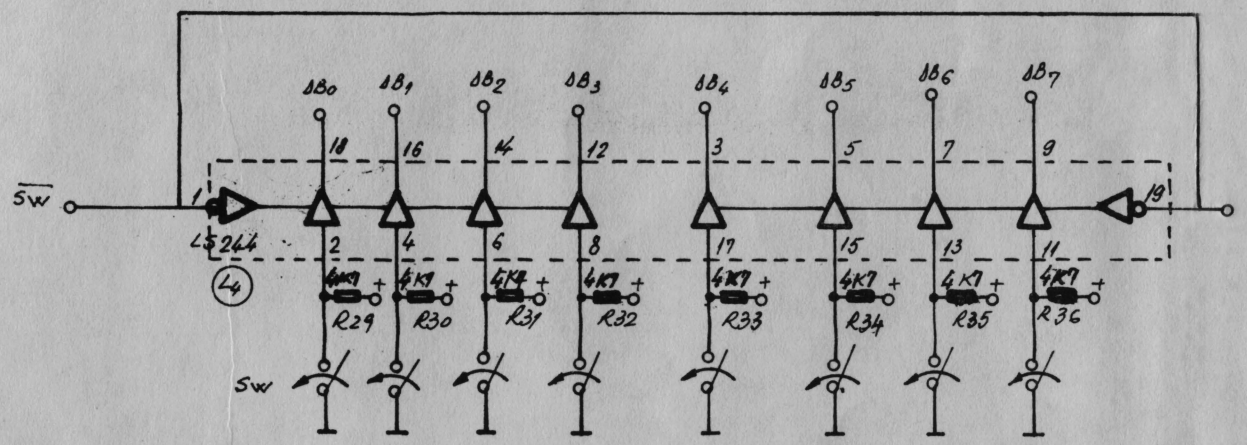
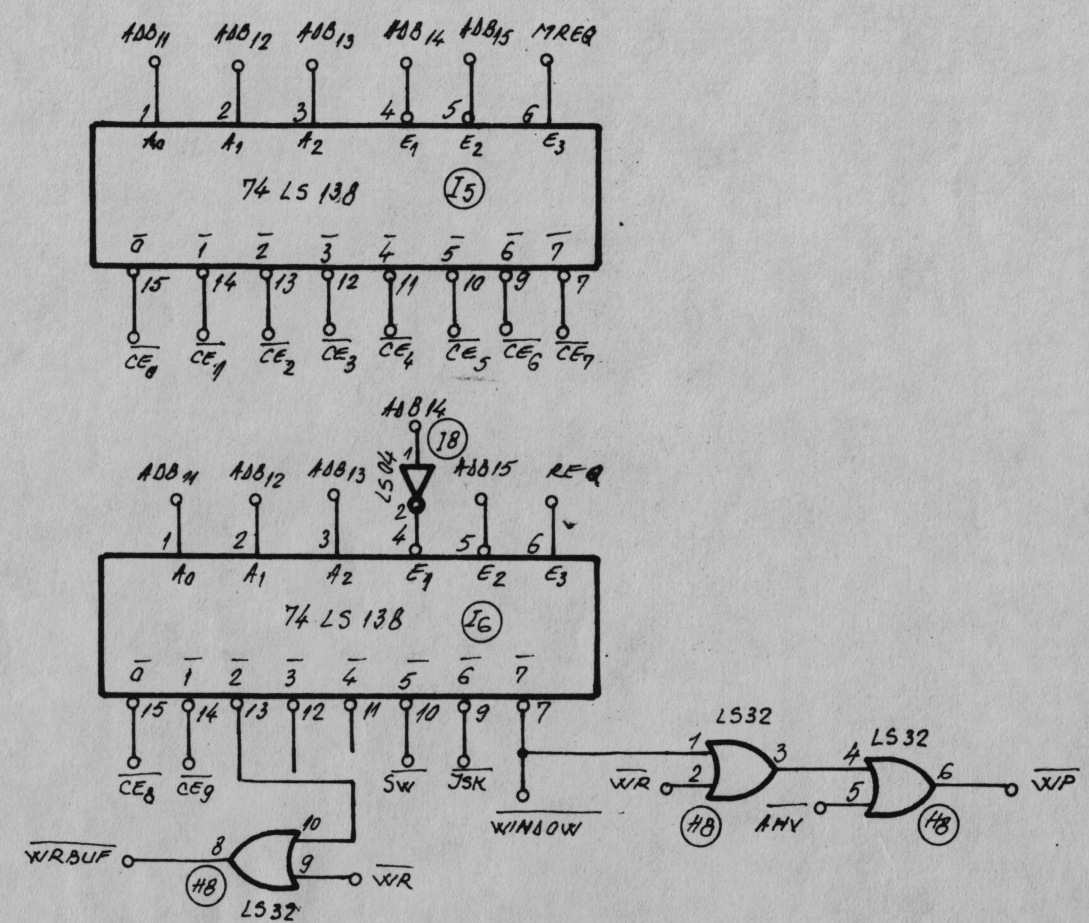
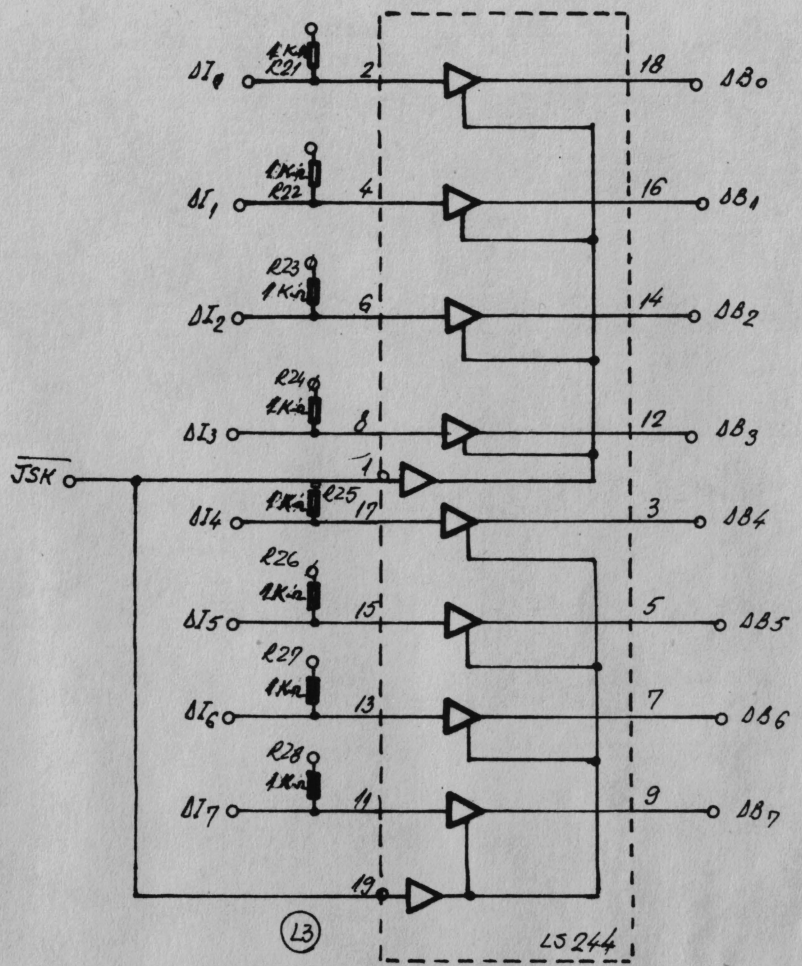

IEP

	902.910.020 Rev.D	Indice: 0
	INTERFATA PARALELA JOYSTICK SI DECODIFICAREA ADRESE	Fila: 4/7
data: 19.11.1987	Produs: ALFAGRAF 200	

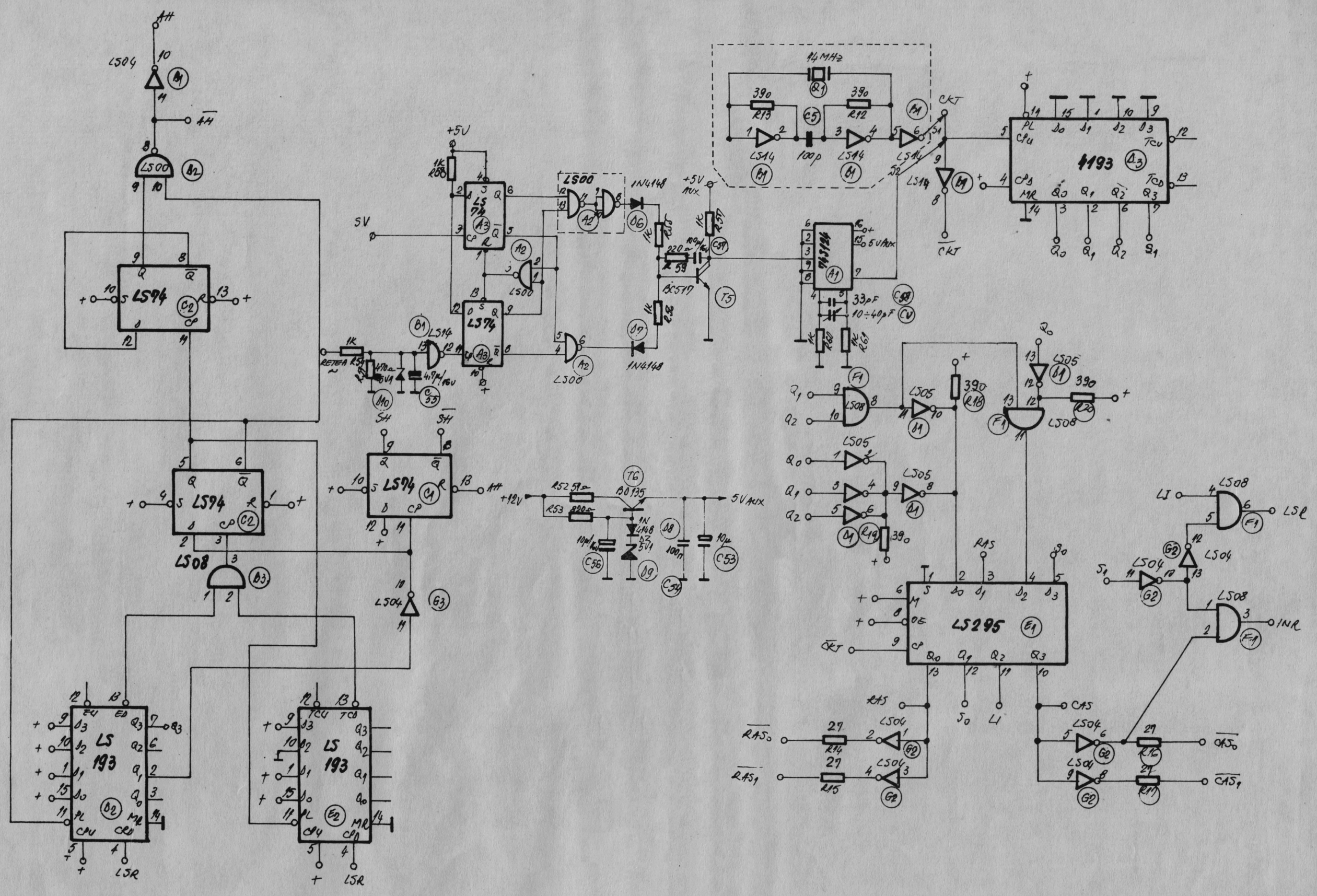

NOTA: Se conectează ștapul S1 pentru oscilatorul cu cuarț
 Se conectează ștapul S2 pentru oscilatorul sincron cu rețeaua
 Oscilatorul cu cuarț 14MHz nu se implantează.

IEP

	902.910.020 Rev. A	Indice 0
	SINCRONIZATOR SI GENERATOR SEMNALE MEMORIE	5/10- 5/17
data: 19.11.1989	Produs: MFAGRAF 200	

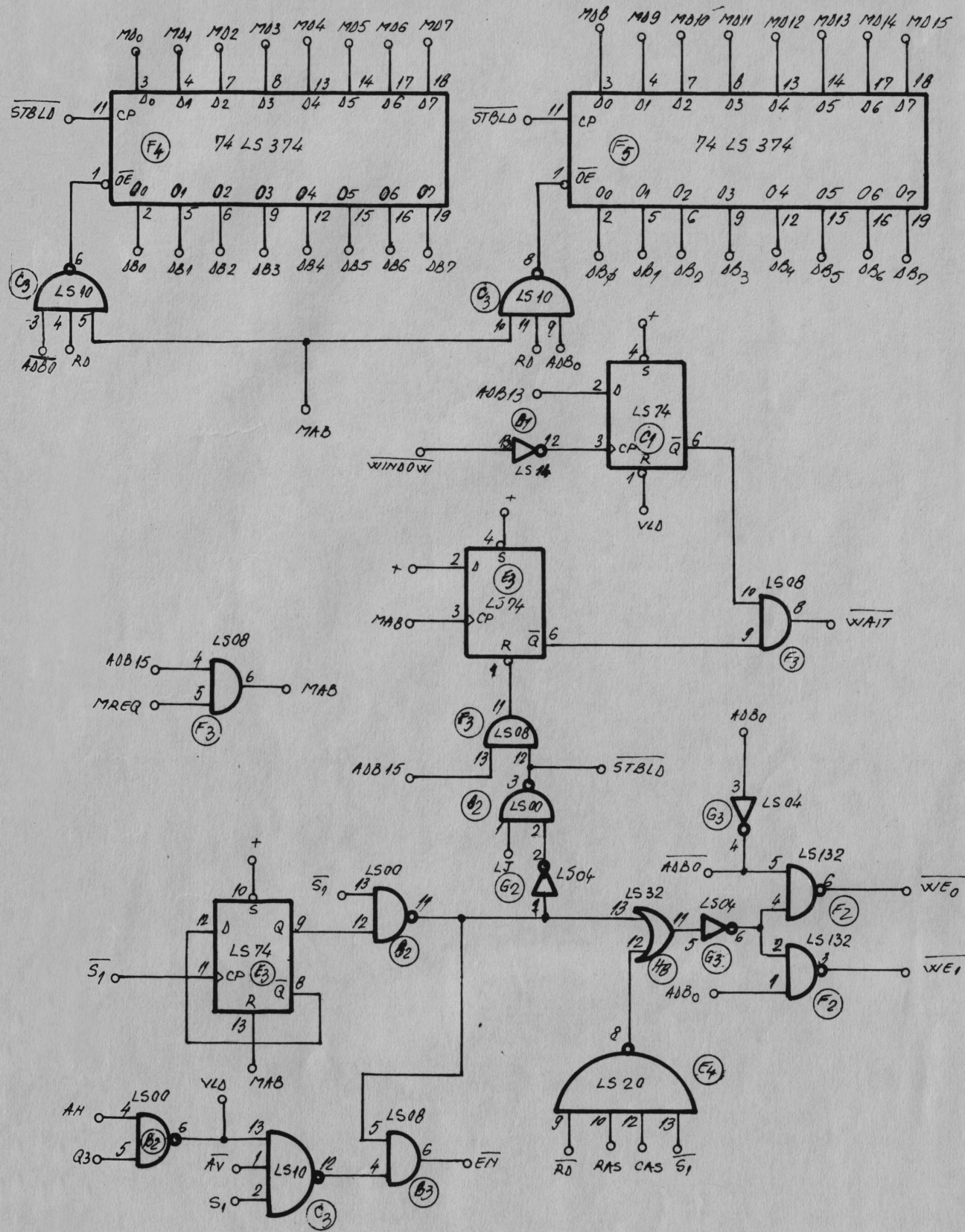
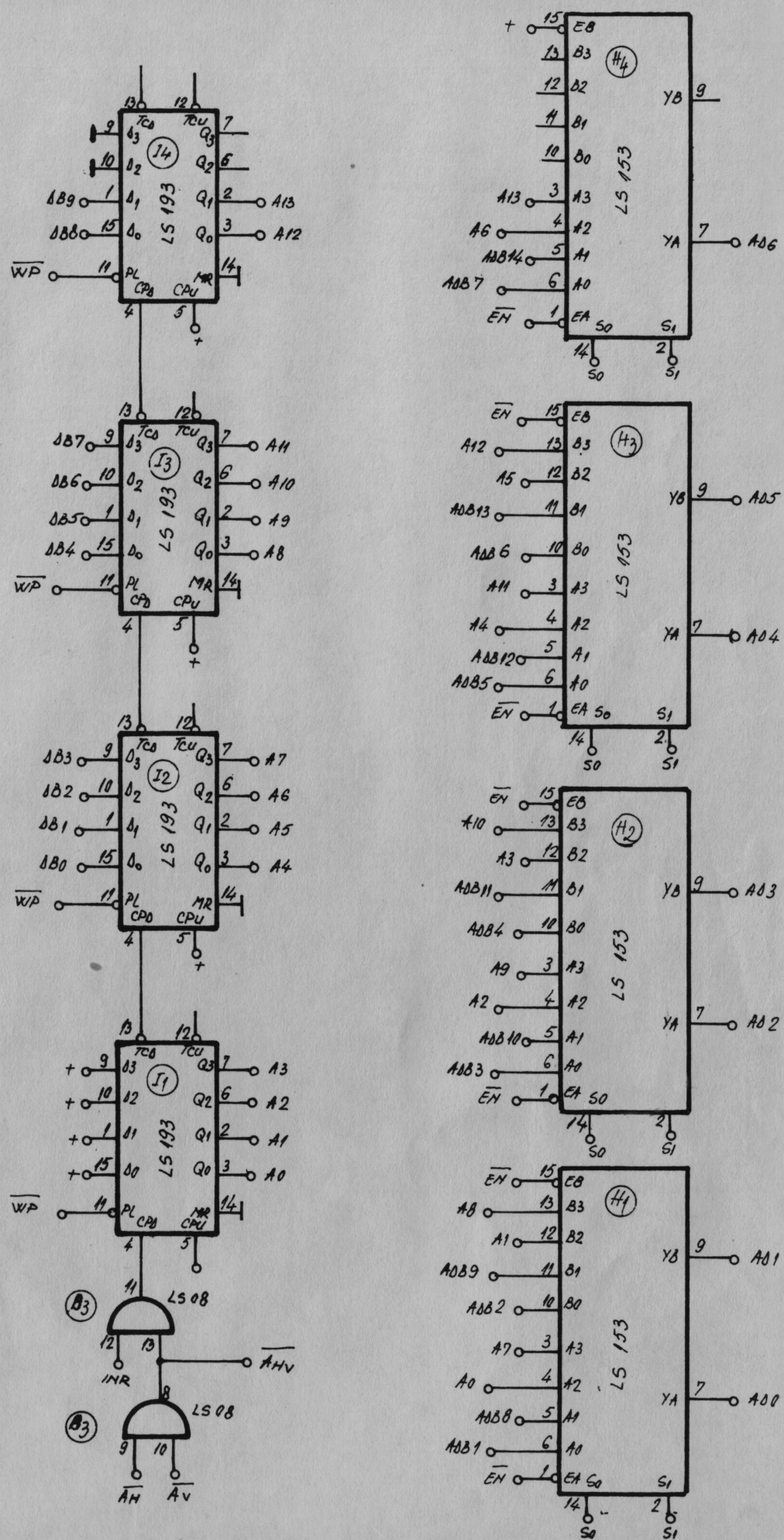

IEP

	702.910.020 Rev. A	indice: 0
	NUMARATORARE SI MULTIPLEXAREA ADRESE MEMORIE CIRCUIT SINCRONIZARE MEMORIE	A/10 6/9
data: 7.11.87	Produs: ALFAGRAF 200	

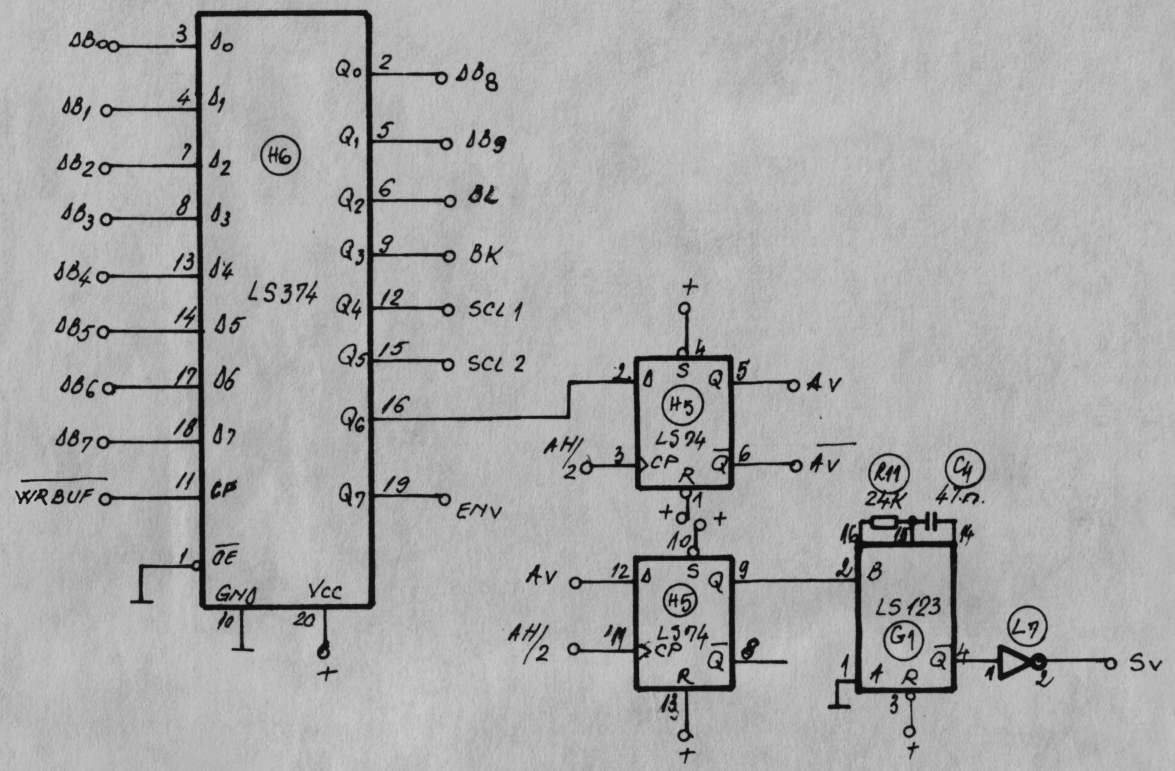
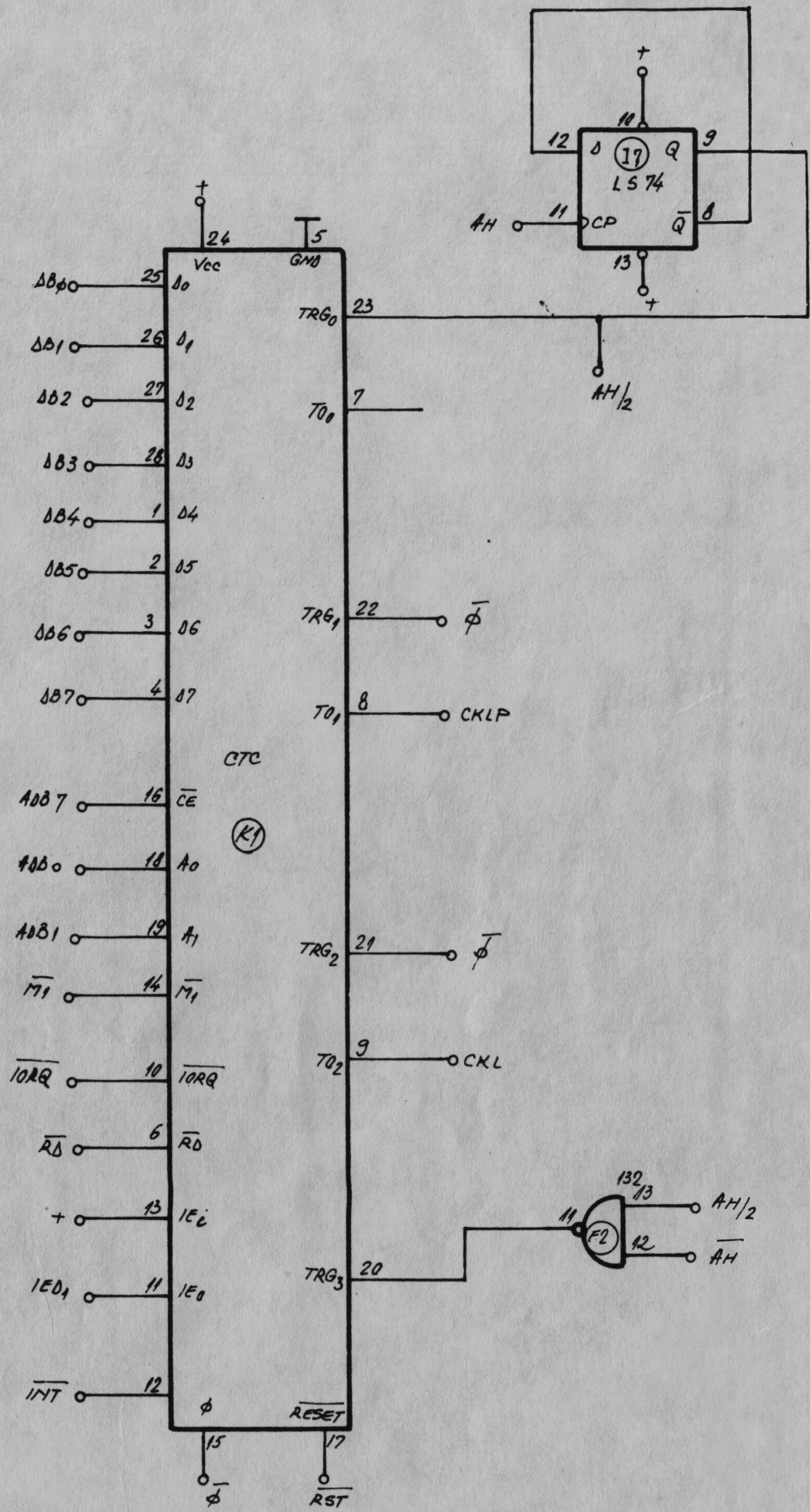

IEP

	702.910.020-Rev. D	Indice: 0
	TIMER ȘI BUFFER CONDITII	A10: 7/7
data: 7.11.1989	Produs: ALFAGRAF 200	

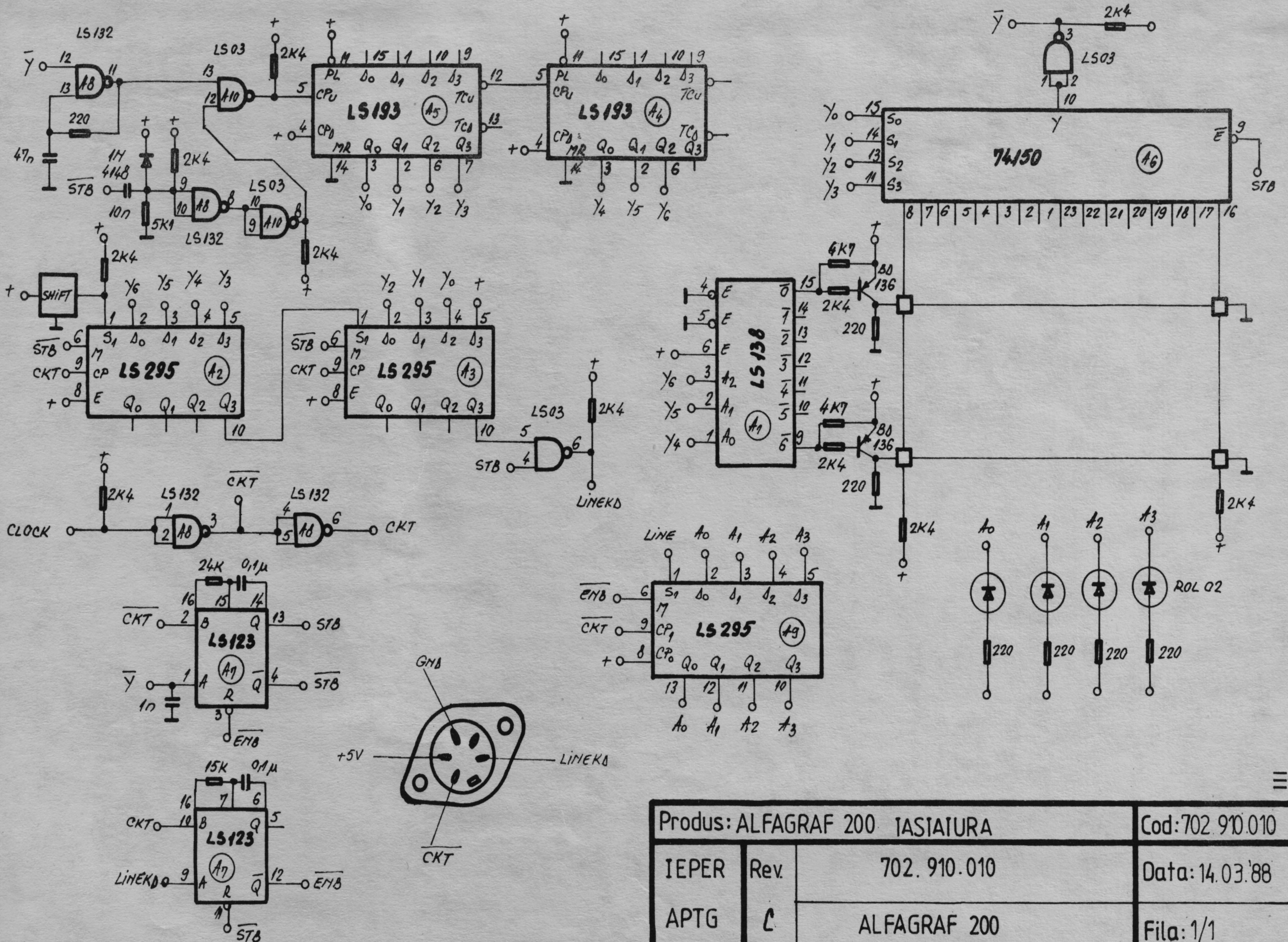

Produs: ALFAGRAF 200 IASIAIURA		Cod: 702 910.010
IEPER	Rev.	702. 910. 010
APTG	Ⓒ	ALFAGRAF 200
		Fila: 1/1

KEYBOARD

SCAMP
 [IGRAF]
 EPSON
 [IMPACT]

1 STOP
 BIT
 2 STOP
 BITS

WORD FORMAT

8 BITS
 NO PARITY
 8 BITS
 ODD PARITY
 8 BITS
 EVEN PARITY
 7 BITS
 NO PARITY
 7 BITS
 ODD PARITY
 7 BITS
 EVEN PARITY

BAUD RATE

150
 300
 600
 1200
 2400
 4800
 9600
 19200

ON

PRINTER

AUX VIDEO

JOYSTICK

SERIAL I/O

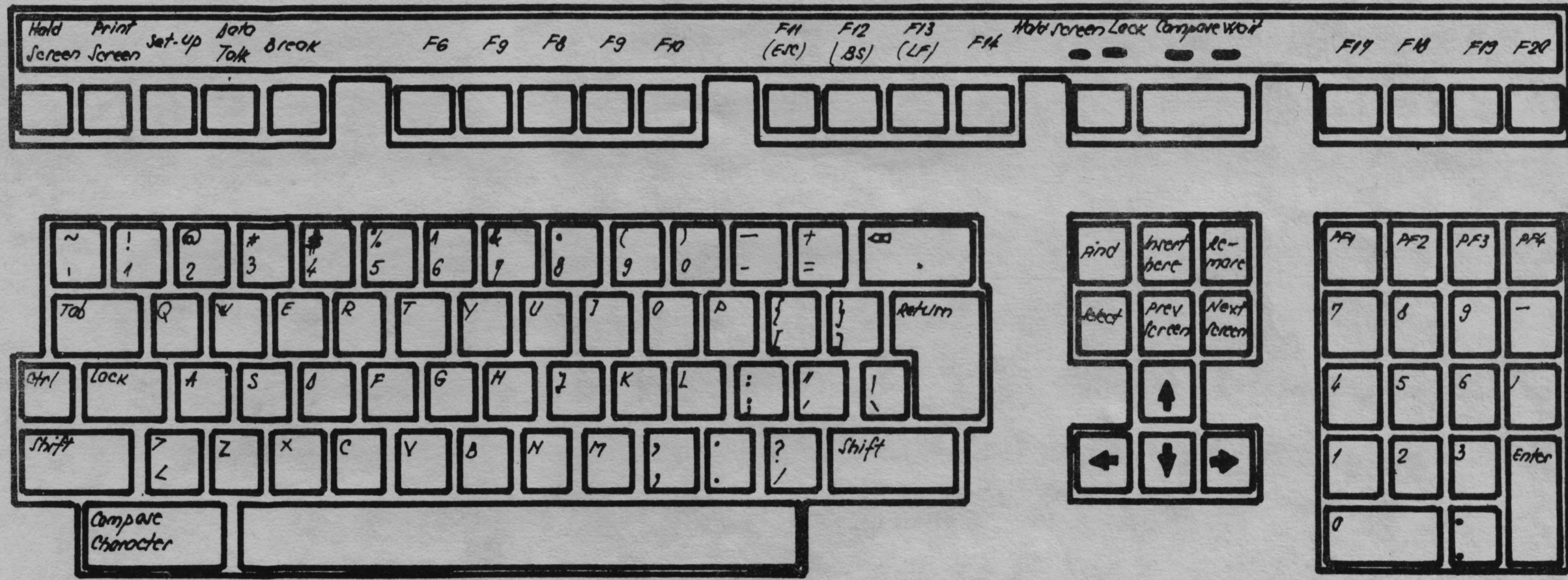

TASTATURA ALFAGRAF-200